



JUNIOR INVENTOR



E3028



JUNIOR
INVENTOR



FREE
INSTRUCTION
APP



<https://www.hape.com/apps>



1:1

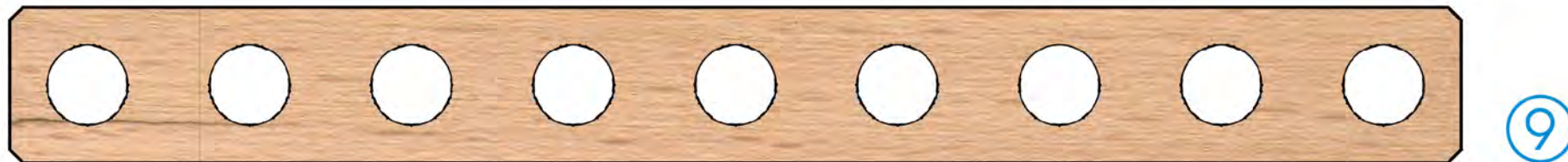
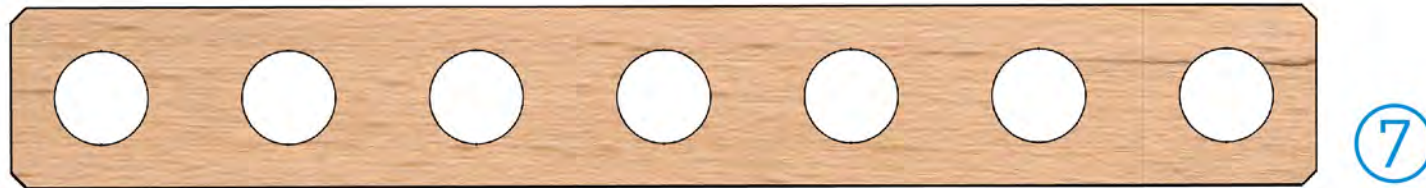
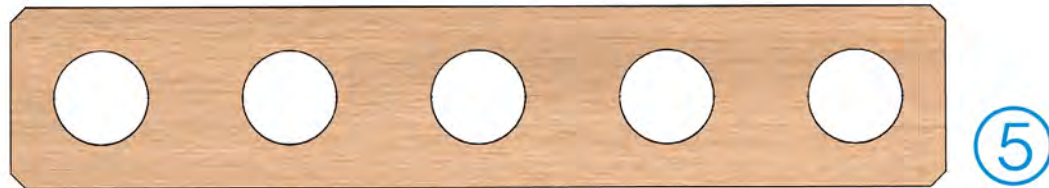
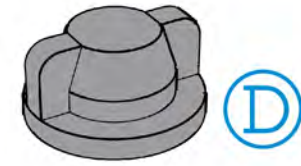
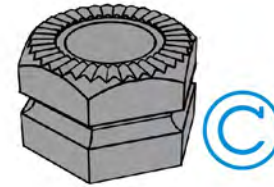
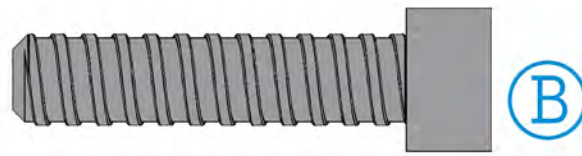
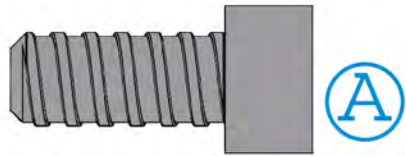



**JUNIOR
INVENTOR**



666050

INVENTOR: _____

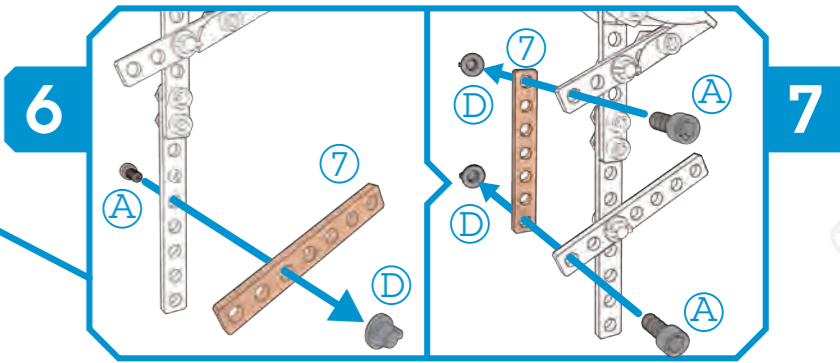
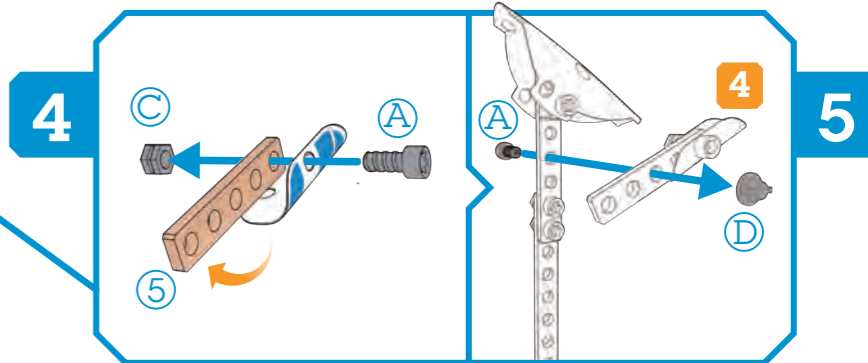
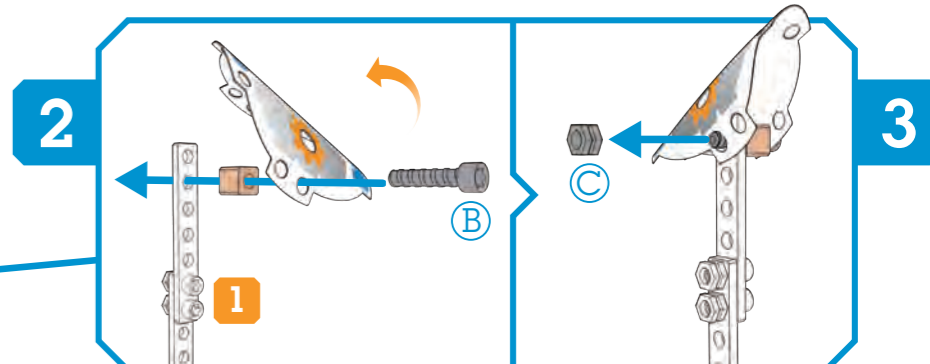
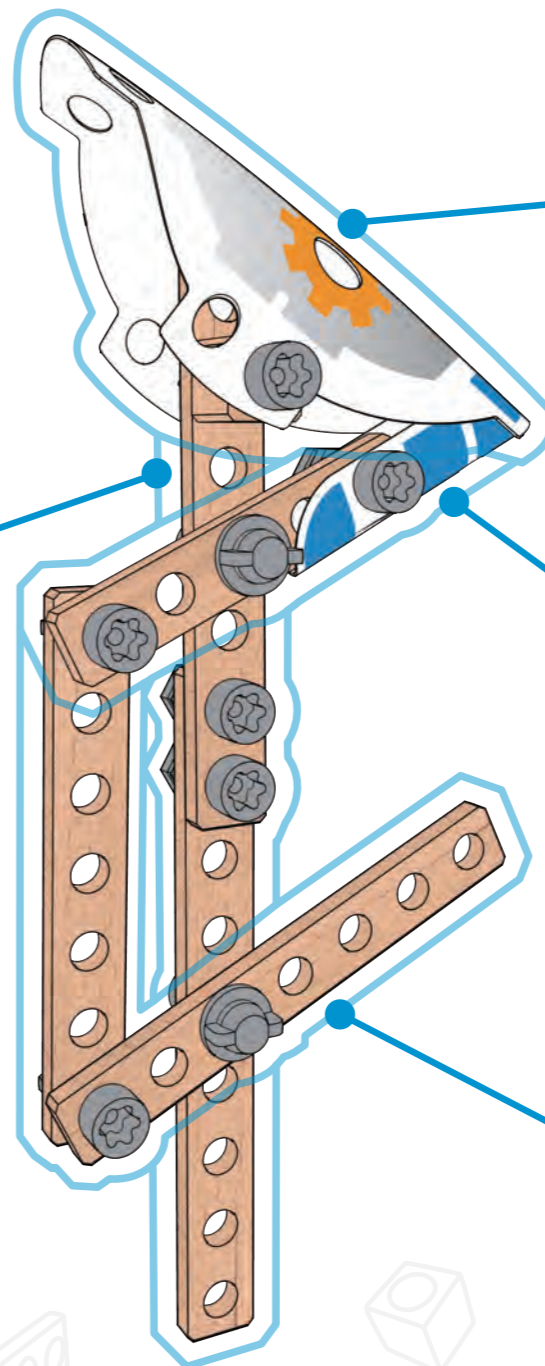
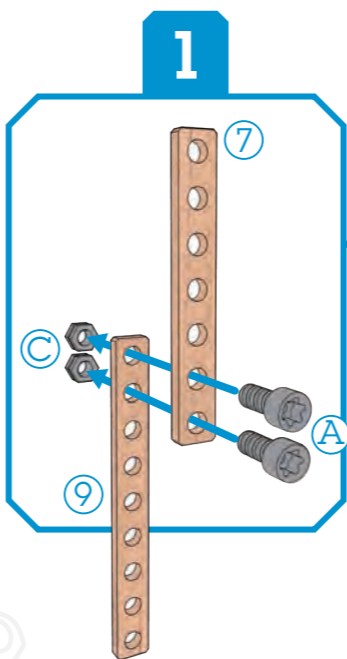
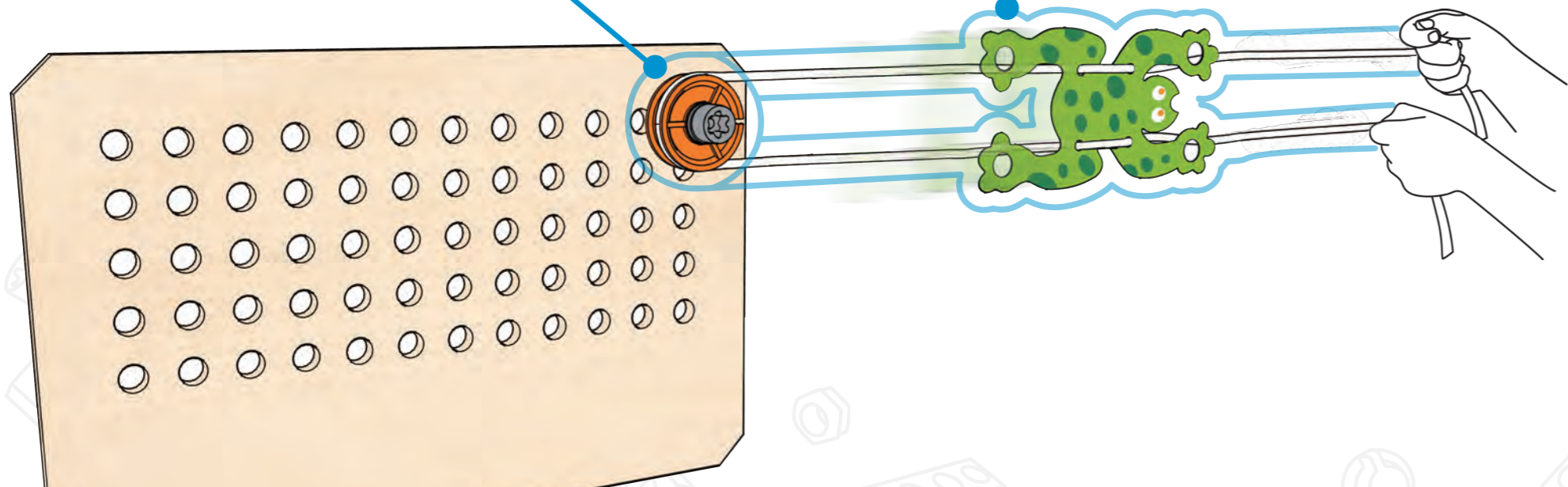
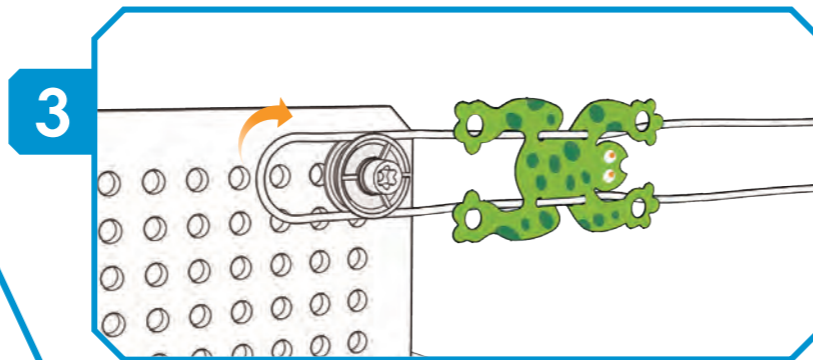
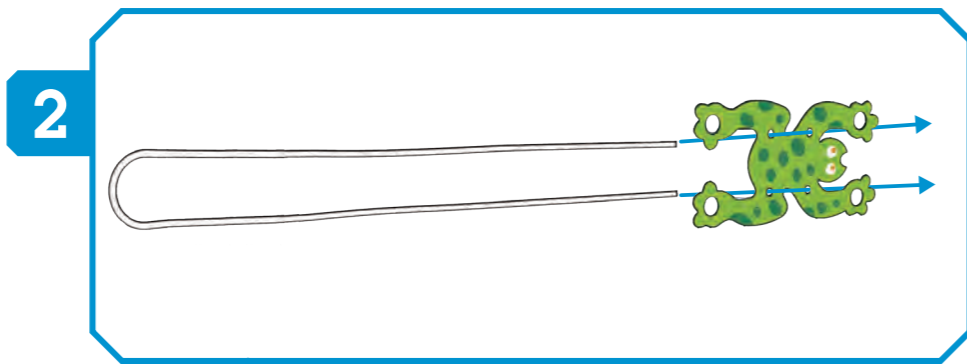
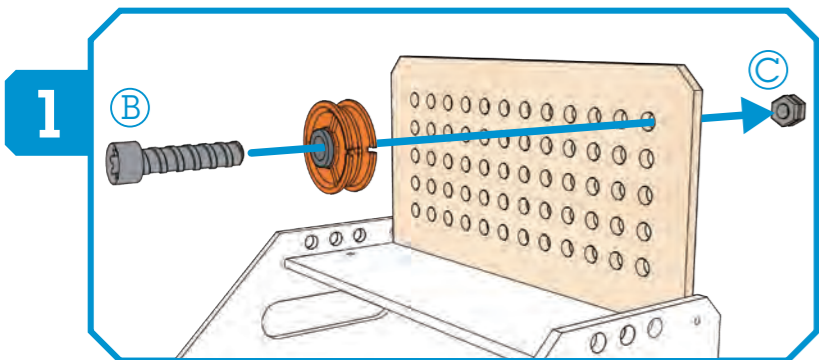

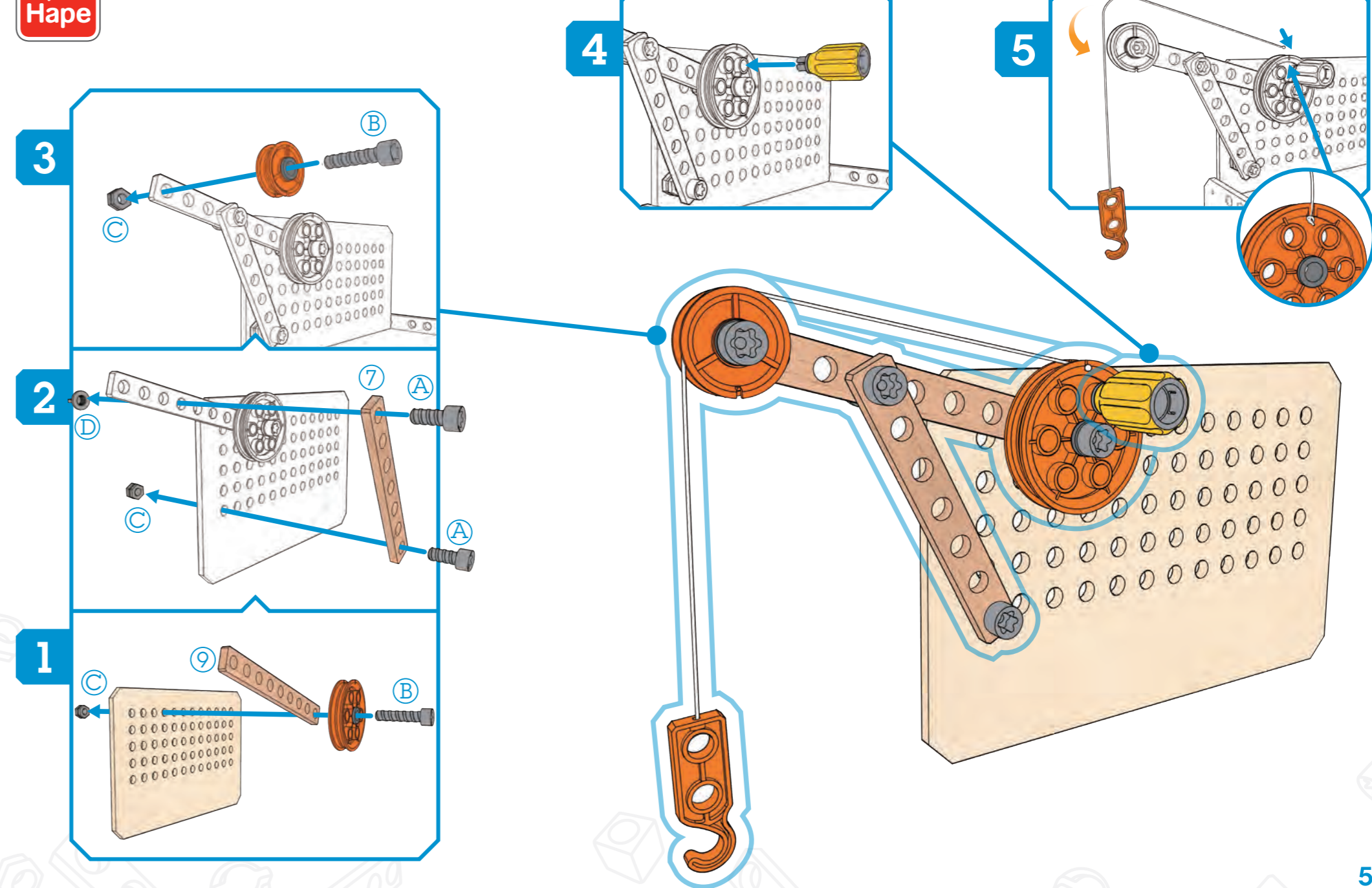
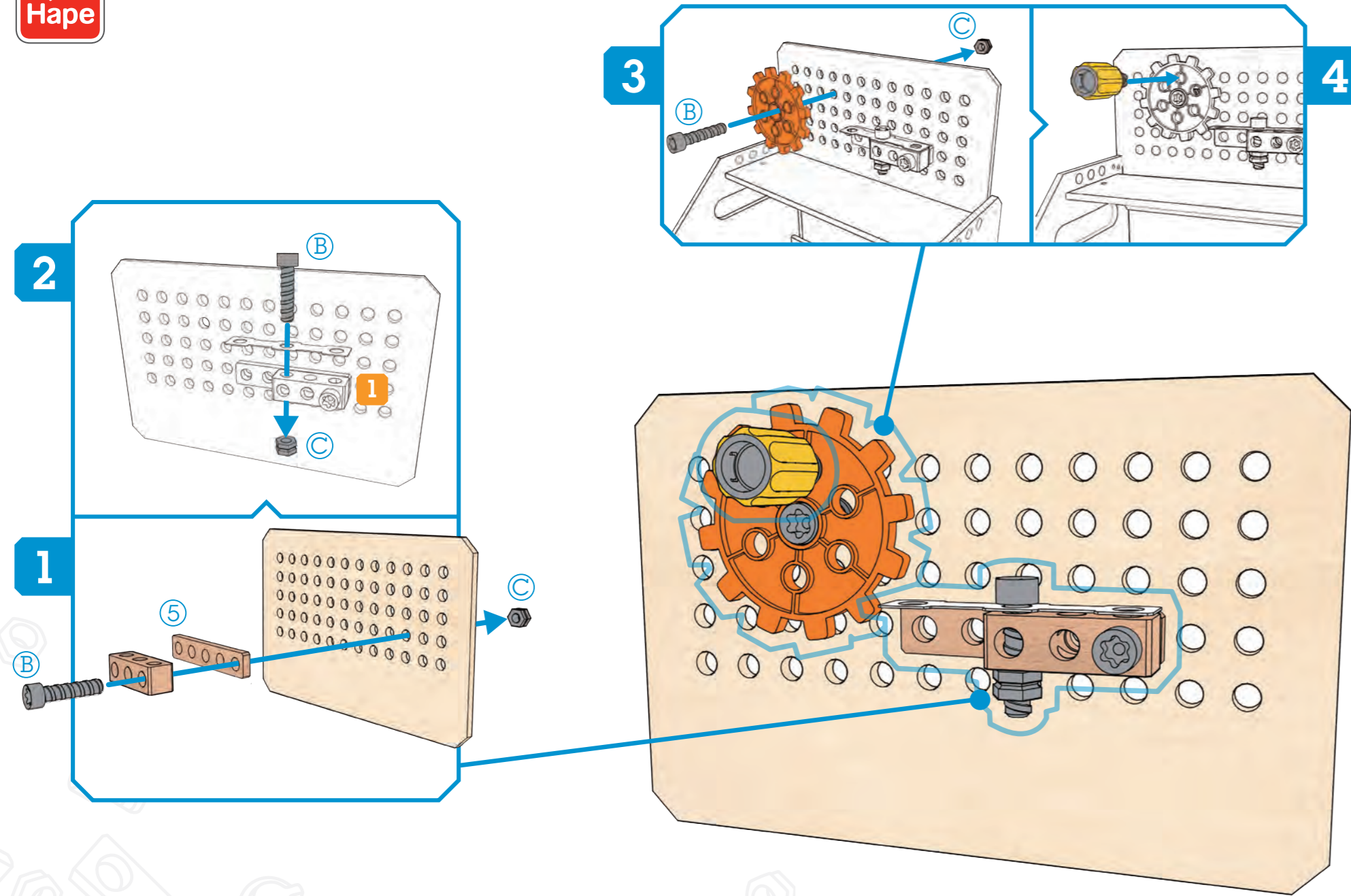

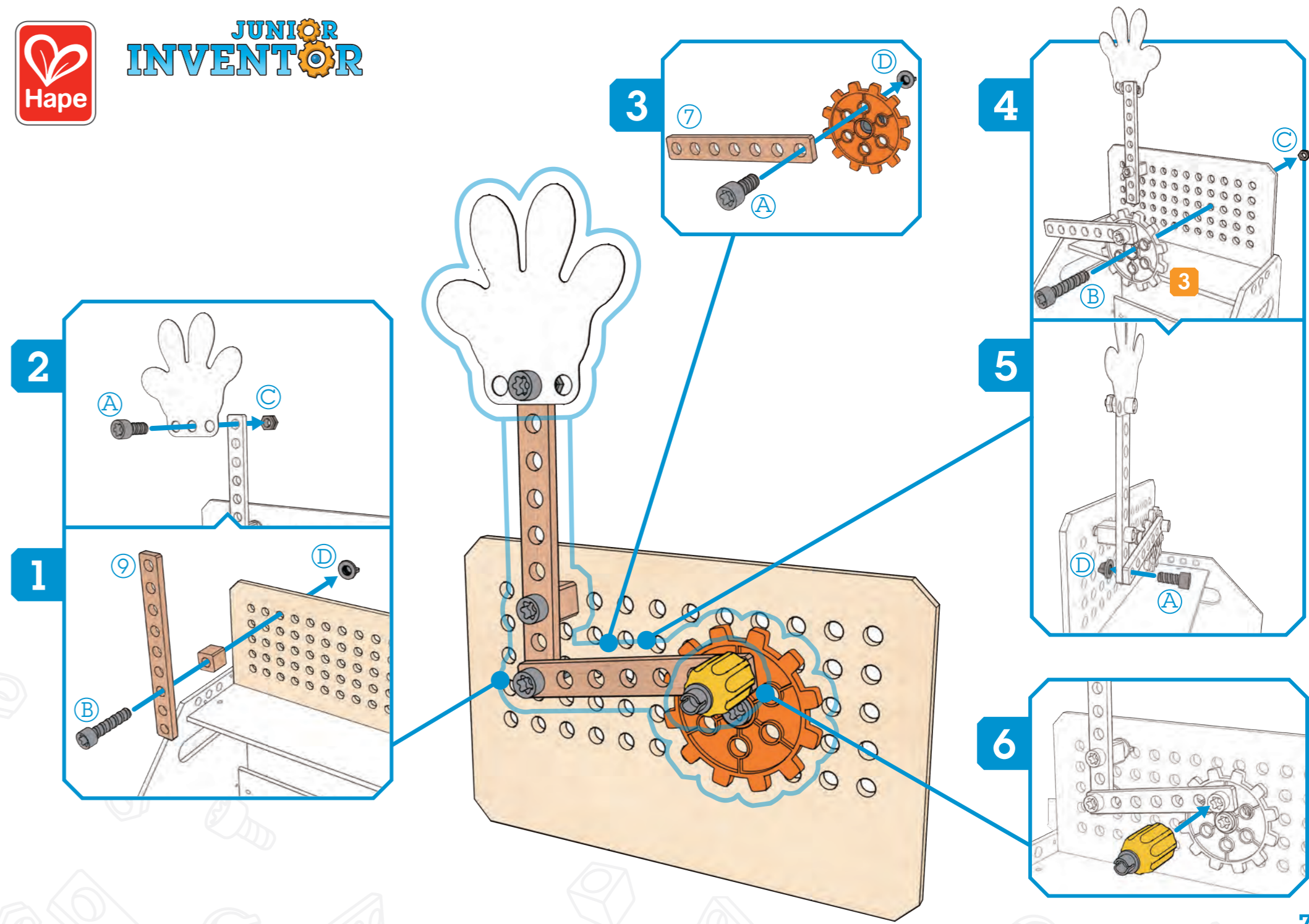
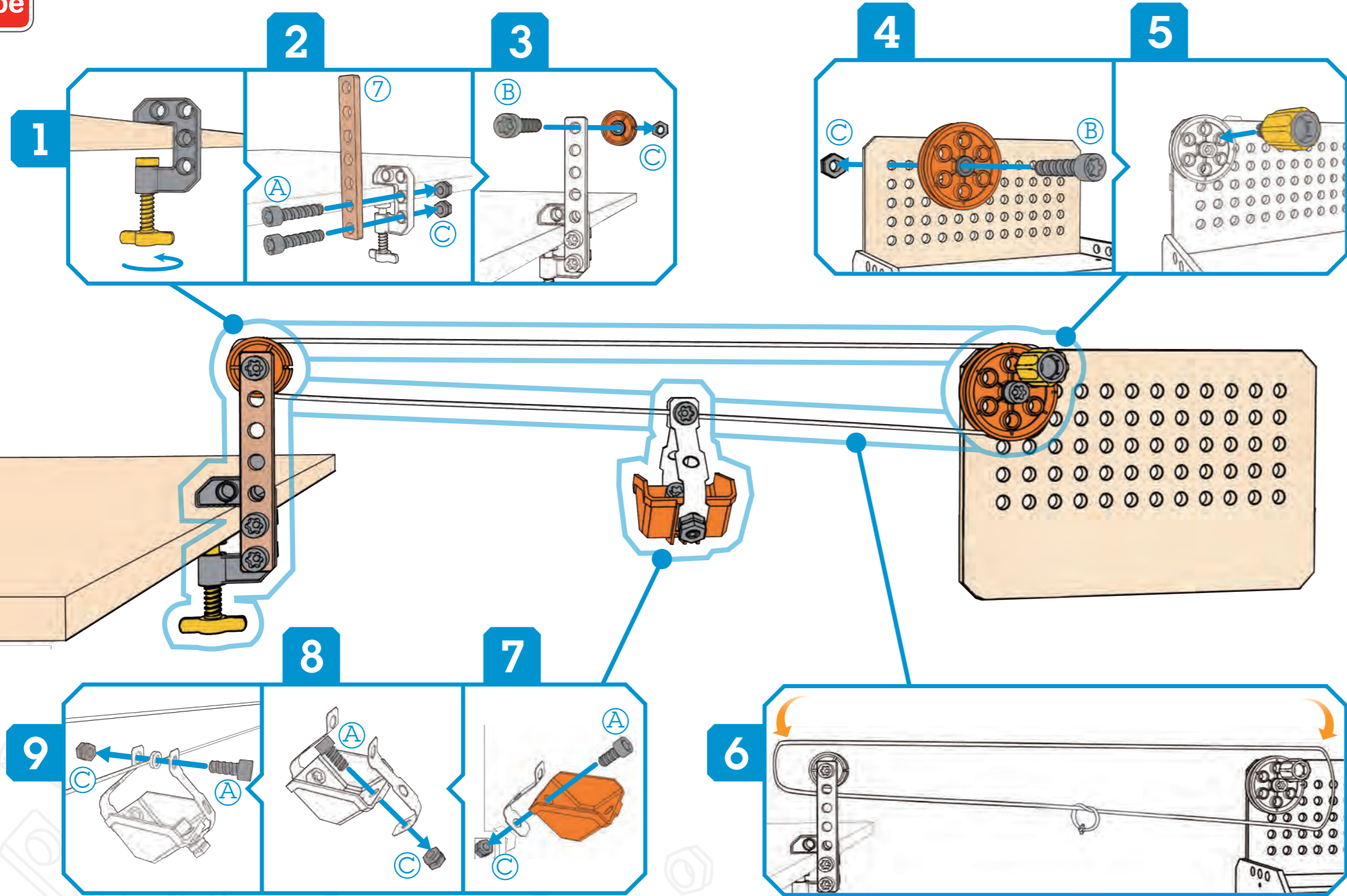

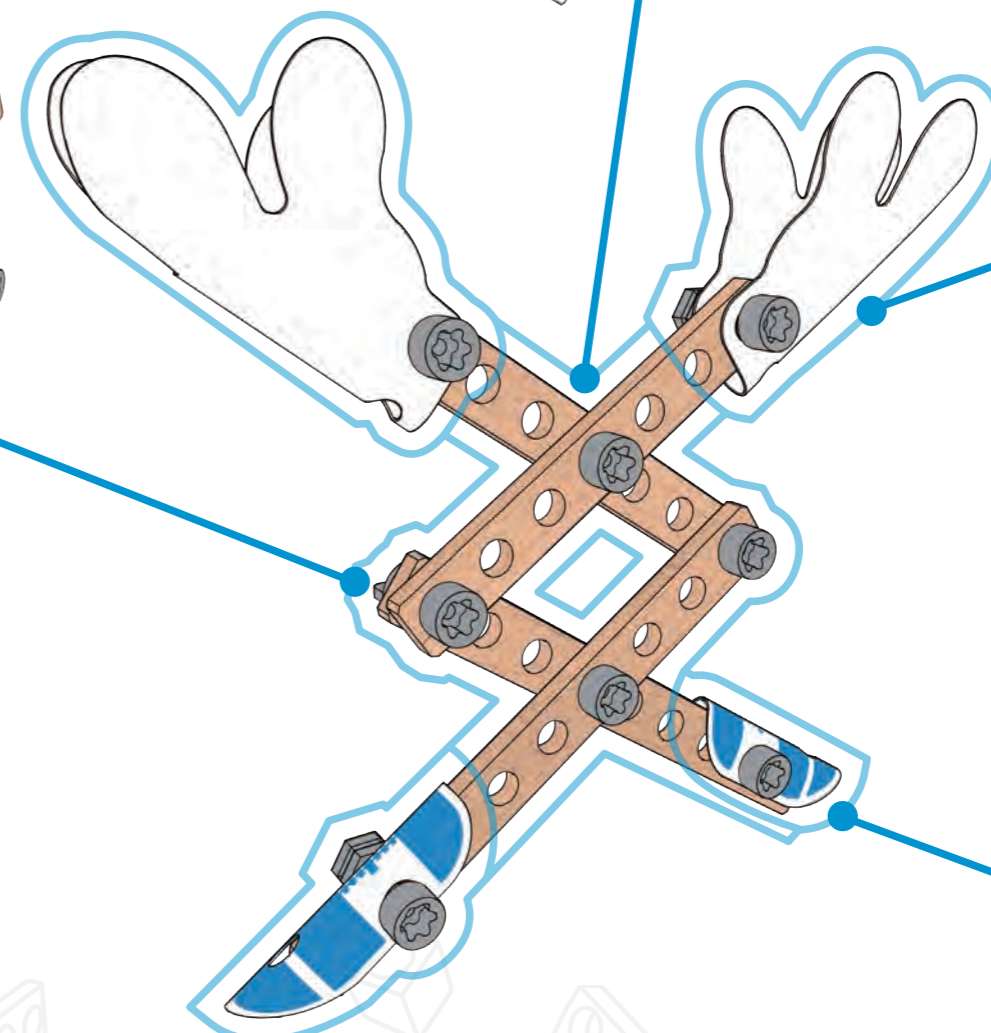
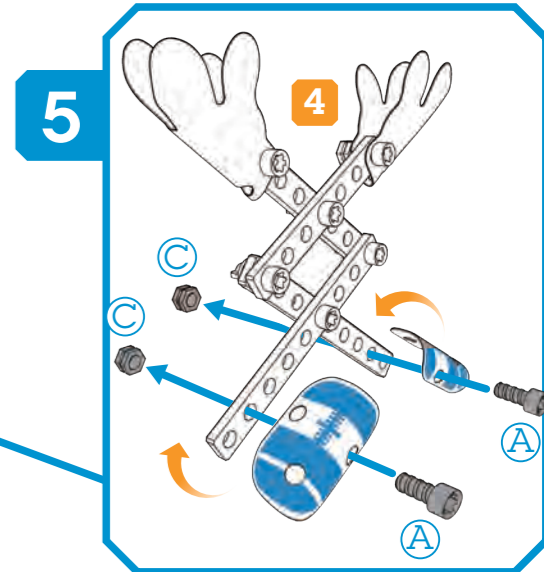
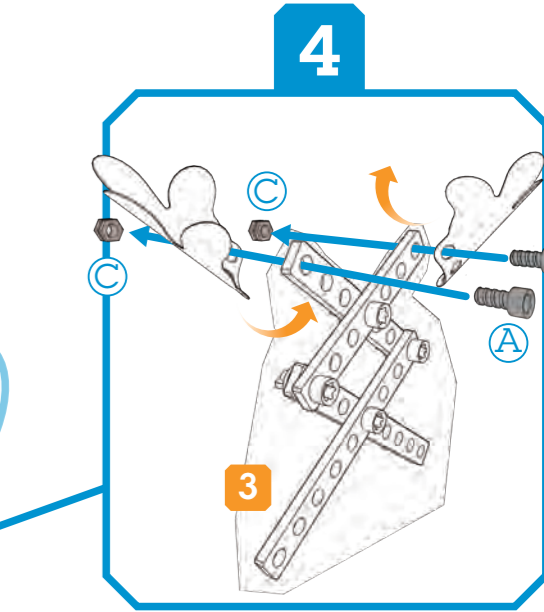
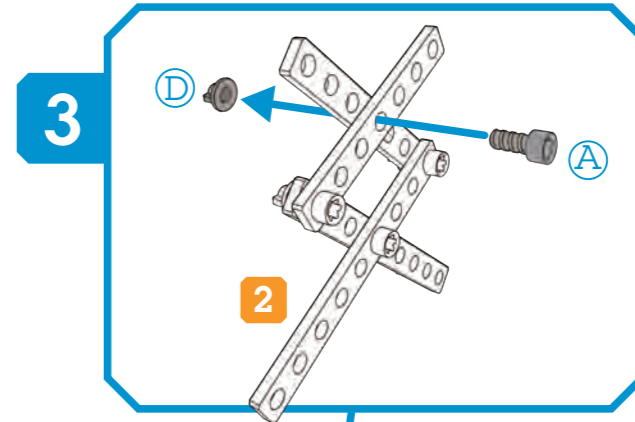
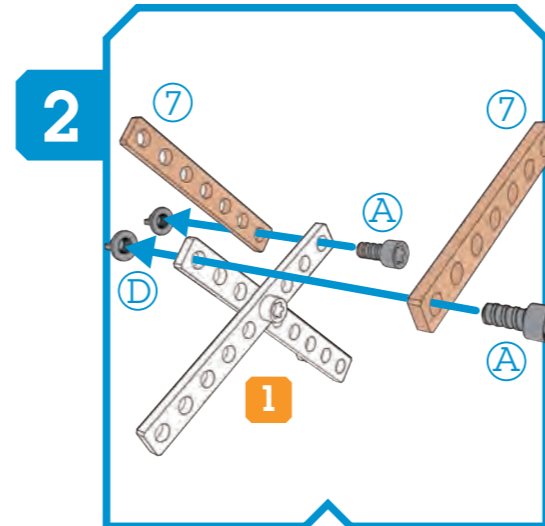
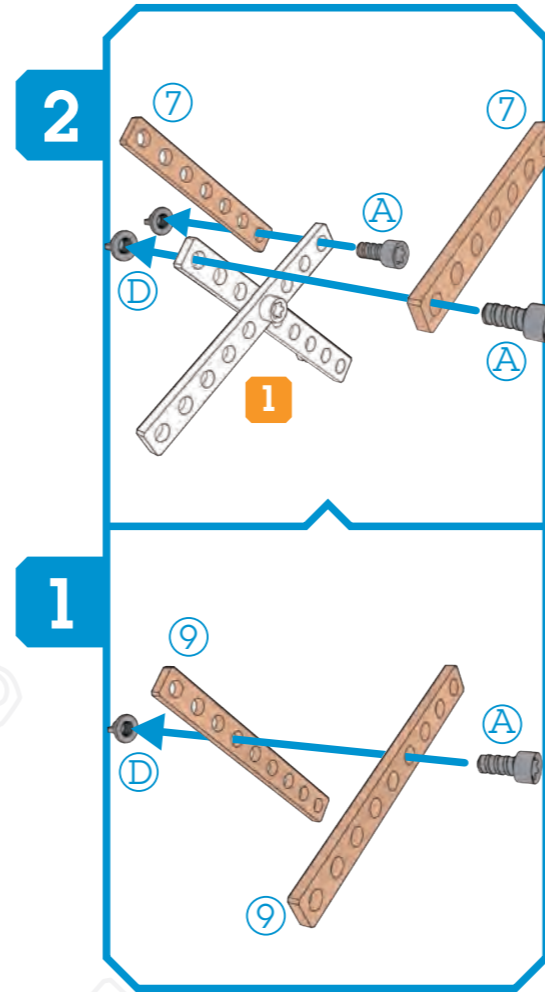
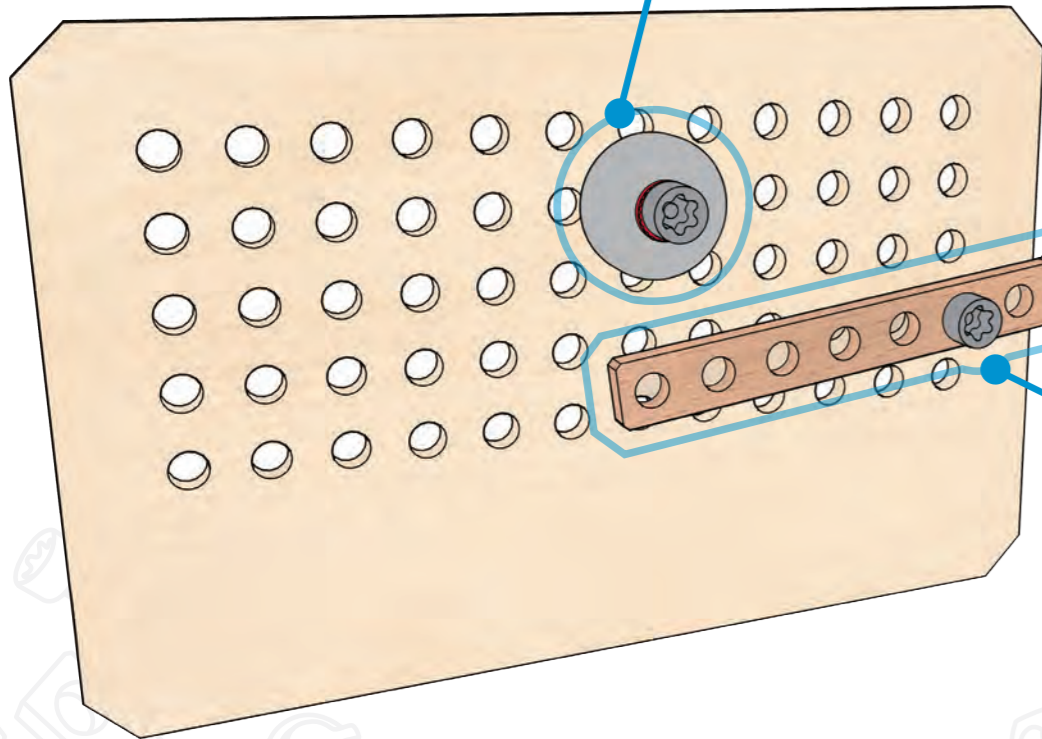
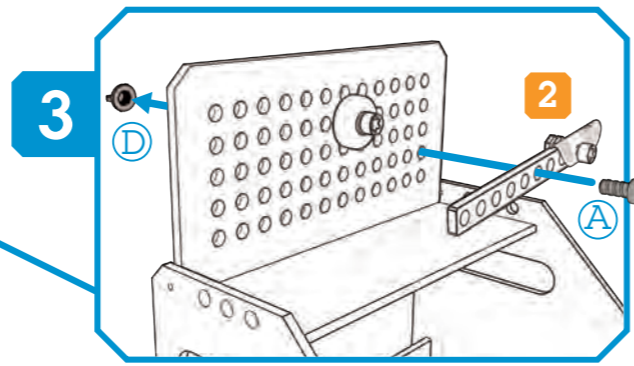
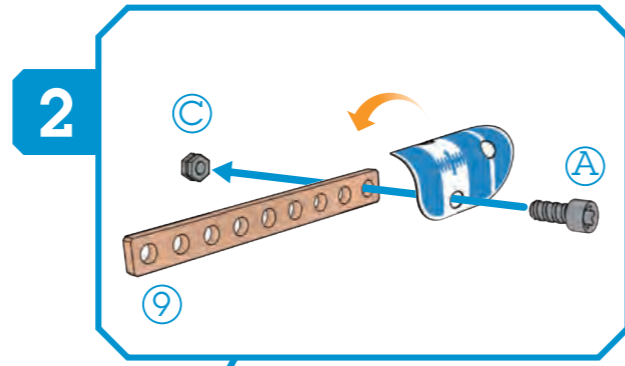
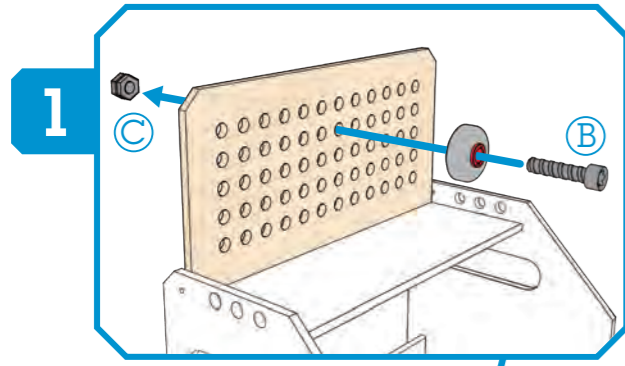

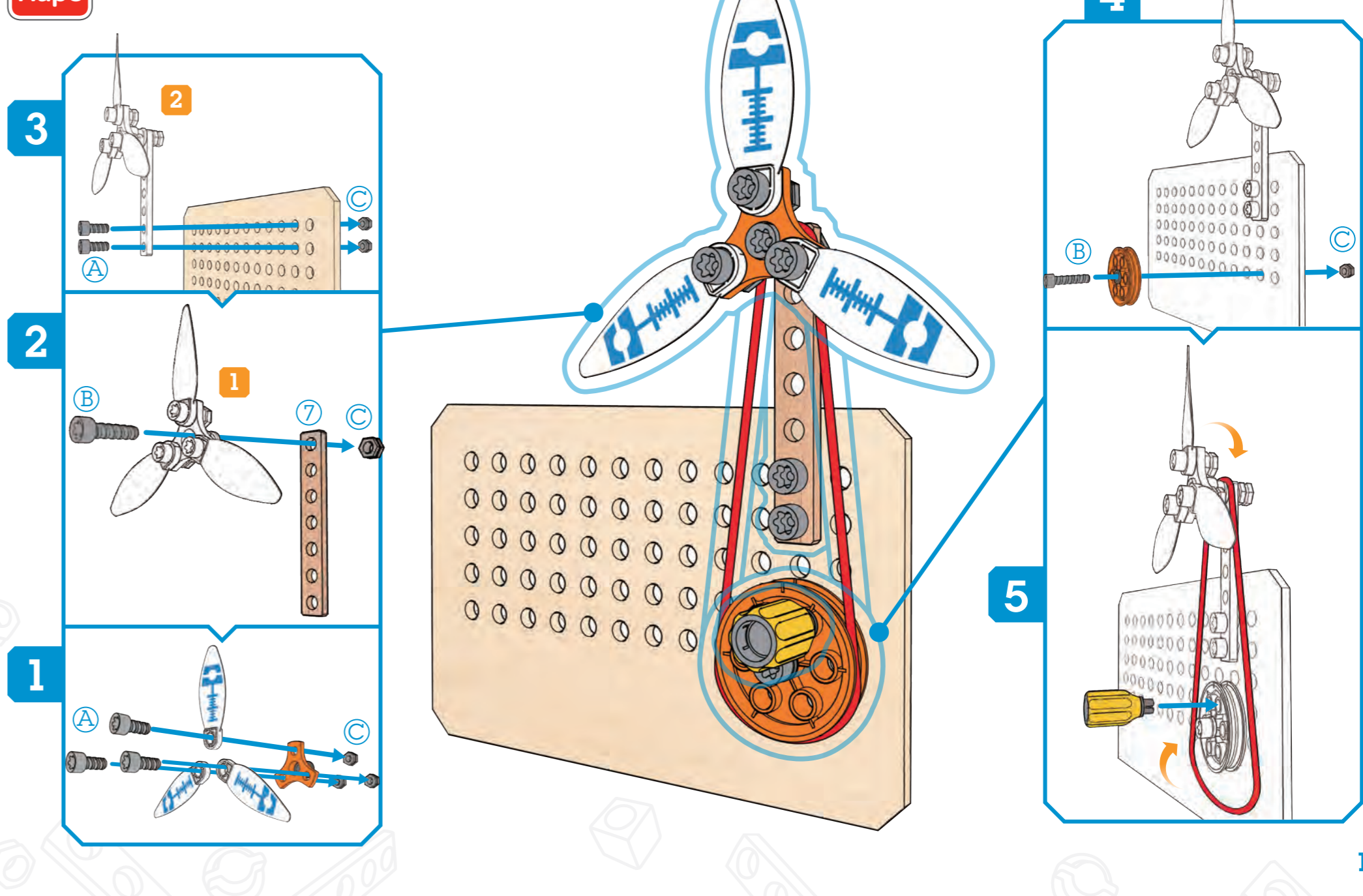
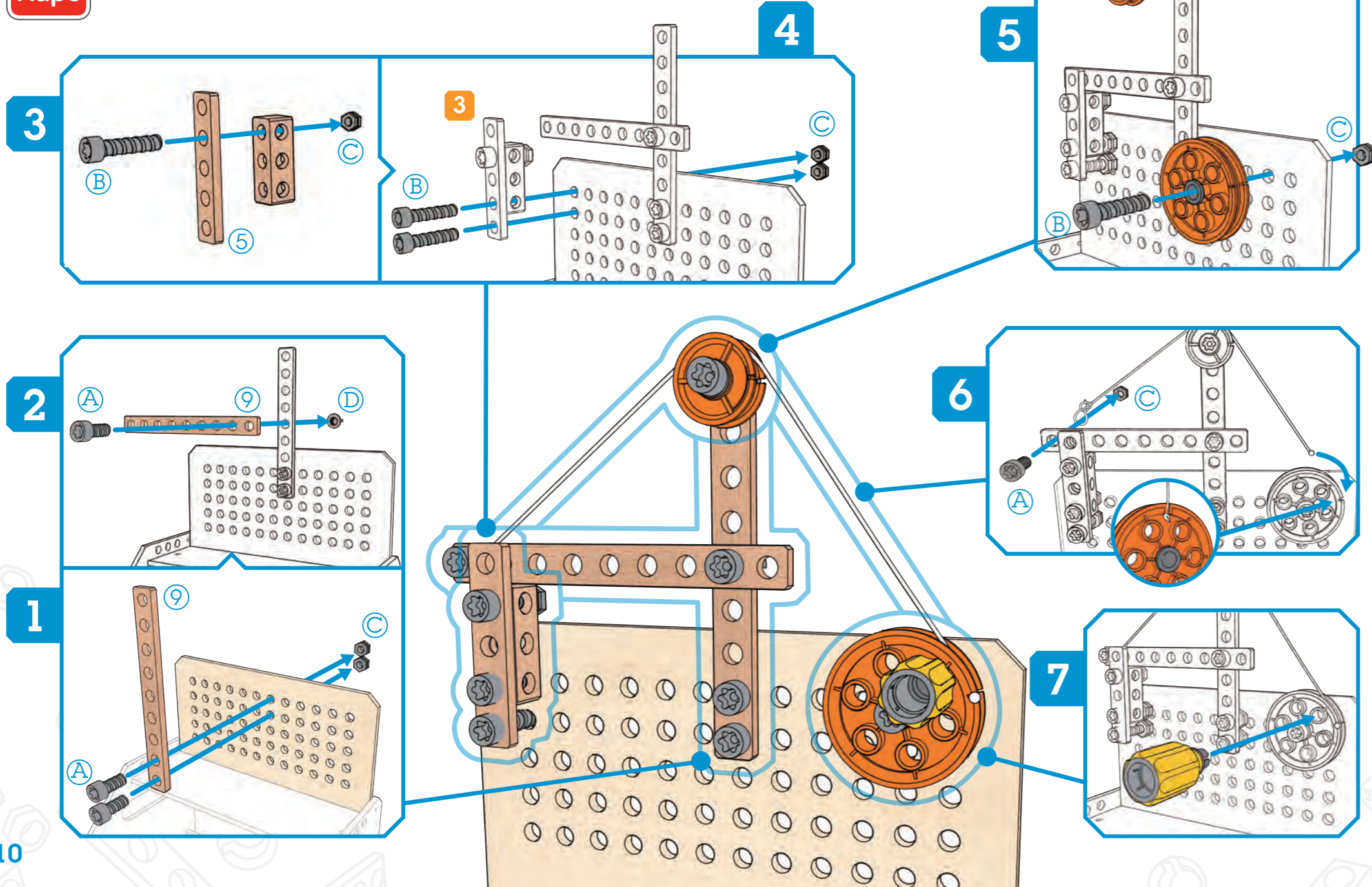



H A P E . C O M

Hape International AG
Alsfelder Straße 41
35325 Mücke
Germany

Hape International Inc.
2nd Floor
199 Pembina Road
Sherwood Park, AB T8H 2W8
Canada